

### RCCN 日成VDRF型环保阻燃线槽 Wide Slot Wiring Duct

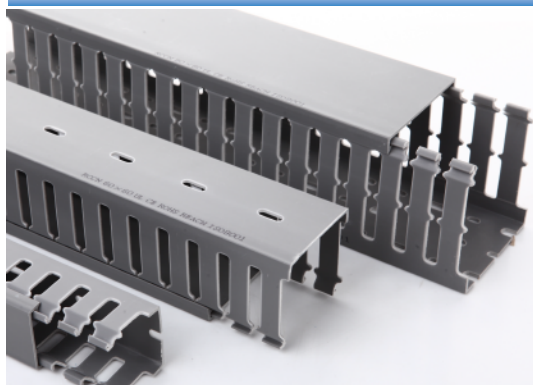

产品材质:采用低卤素硬质PVC料制成,环保无污染,不含铅等有毒物。  
 产品认证:美国UL:E306674 欧洲CE 欧洲环保RoHS,REACH,铁道阻燃低烟。  
 防火等级:UL94V-0,低烟微卤,遇火不燃烧,防火性及绝缘性特佳。  
 产品构造:由槽底及槽盖组成,底槽两侧设有出线孔。  
 颜色:灰色.白色.蓝色.黑色(可定制其它颜色,有起订量要求)  
 工作温度:静态-40°C持续高温至65°C,短时间可达85°C。  
 使用方法:先将底槽固定,将所要配的线装入槽内,盖上槽盖即可。  
 产品特性:1.反扣式槽盖与槽体设计组合后绝不脱落,且接合面平滑,不割伤手及擦损附近配线。  
 2.配线槽65°C内不易断裂,变形,变色,装配省时便利。  
 3.出线孔低、组合容易、拆卸简单、易于配线。

**更多选择:量大可按需求生产所需规格或定制长度.例:VDR8080F(L=1.7M)**  
 Wide slot/finger design provides greater sidewall rigidity and can be used with a wide range of wire bundle sizes.  
 Certificates:UL:E306674 CE:EN50085 RoHS,REACH. Made of rigid PVC  
 Work temperature:-40 °c to 65 °c  
 UL94 Flammability Rating of V-0  
 Provided with mounting holes  
 Available color:gray.white.blue.black and other special colors  
**Special length come with MOQ request**



推荐:灰色为常规库存产品,其它颜色有起订量要求。  
 Comment : gray is the common color, other color need more MOQ

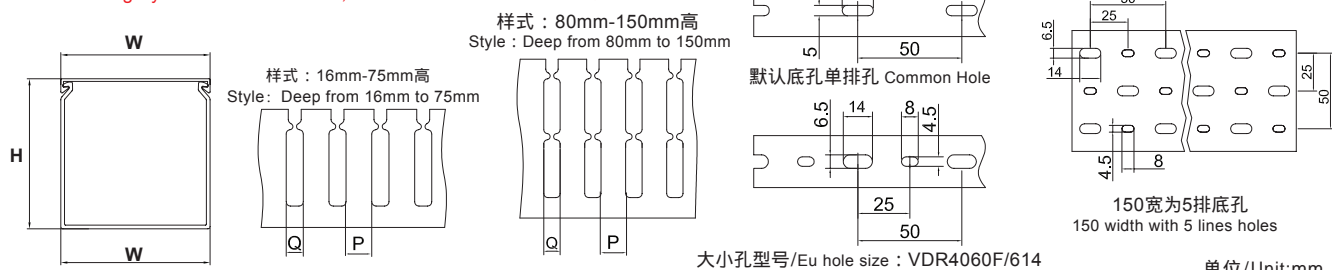

大小孔型号/Eu hole size : VDR4060F/614

单位/Unit:mm

| 型号 Item No.       |                    |                   |                    | 宽×高<br>High X width<br>W×H | 孔宽<br>Slot<br>width<br>Q | 齿宽<br>Finger<br>width<br>P | 电线容量<br>以2.0平方计算<br>Wire capability/2.0sq | 标准长度<br>Standard<br>Length |
|-------------------|--------------------|-------------------|--------------------|----------------------------|--------------------------|----------------------------|---|----------------------------|
| 灰色Gray<br>RAL7030 | 白色White<br>RAL9016 | 蓝色Blue<br>RAL5015 | 黑色Black<br>RAL9005 | 16×16                      | 8                        | 10                         | 3~10pcs                                   | 每支<br>2米<br>含槽底槽盖          |
| VDR1616F          | VDR1616FW          | VDR1616FE         | VDR1616FB          | 25×16                      | 8                        | 10                         | 8~12pcs                                   |                            |
| VDR2516F          | VDR2516FW          | VDR2516FE         | VDR2516FB          | 15×20                      | 8.5                      | 12                         | 8~12pcs                                   |                            |
| VDR1520F          | VDR1520FW          | VDR1520FE         | VDR1520FB          | 20×20                      | 8.5                      | 12                         | 10~20pcs                                  |                            |
| VDR2020F          | VDR2020FW          | VDR2020FE         | VDR2020FB          | 40×20                      | 8                        | 12                         | 15~30pcs                                  |                            |
| VDR4020F          | VDR4020FW          | VDR4020FE         | VDR4020FB          | 15×25                      | 8                        | 10                         | 5~15pcs                                   |                            |
| VDR1525F          | VDR1525FW          | VDR1525FE         | VDR1525FB          | 20×25                      | 8                        | 10                         | 5~15pcs                                   |                            |
| VDR2025F          | VDR2025FW          | VDR2025FE         | VDR2025FB          | 25×25                      | 8                        | 10                         | 10~25pcs                                  |                            |
| VDR2525F          | VDR2525FW          | VDR2525FE         | VDR2525FB          | 30×25                      | 8                        | 10                         | 12~28pcs                                  |                            |
| VDR3025F          | VDR3025FW          | VDR3025FE         | VDR3025FB          | 40×25                      | 8                        | 10                         | 20~35pcs                                  |                            |
| VDR4025F          | VDR4025FW          | VDR4025FE         | VDR4025FB          | 50×25                      | 8                        | 10                         | 12~28pcs                                  |                            |
| VDR5025F          | VDR5025FW          | VDR5025FE         | VDR5025FB          | 15×30                      | 8                        | 10                         | 8~15pcs                                   | Pcs/Branch<br>2M           |
| VDR1530F          | VDR1530FW          | VDR1530FE         | VDR1530FB          | 20×30                      | 8                        | 12                         | 25~35pcs                                  |                            |
| VDR2030F          | VDR2030FW          | VDR2030FE         | VDR2030FB          | 25×30                      | 8                        | 12                         | 25~35pcs                                  |                            |
| VDR2530F          | VDR2530FW          | VDR2530FE         | VDR2530FB          | 30×30                      | 8                        | 12                         | 25~35pcs                                  |                            |
| VDR3030F          | VDR3030FW          | VDR3030FE         | VDR3030FB          | 40×30                      | 8                        | 12                         | 30~40pcs                                  |                            |
| VDR4030F          | VDR4030FW          | VDR4030FE         | VDR4030FB          | 50×30                      | 8                        | 12                         | 40~50pcs                                  |                            |
| VDR5030F          | VDR5030FW          | VDR5030FE         | VDR5030FB          | 60×30                      | 8                        | 12                         | 50~60pcs                                  |                            |
| VDR6030F          | VDR6030FW          | VDR6030FE         | VDR6030FB          | 22×33                      | 6                        | 10.5                       | 25~35pcs                                  |                            |
| VDR2233F          | VDR2233FW          | VDR2233FE         | VDR2233FB          | 33×33                      | 8                        | 12                         | 35~45pcs                                  |                            |
| VDR3333F          | VDR3333FW          | VDR3333FE         | VDR3333FB          | 20×35                      | 8                        | 12                         | 30~40pcs                                  |                            |
| VDR2035F          | VDR2035FW          | VDR2035FE         | VDR2035FB          | 35×35                      | 8                        | 12                         | 35~45pcs                                  |                            |
| VDR3535F          | VDR3535FW          | VDR3535FE         | VDR3535FB          | 50×35                      | 8                        | 12                         | 40~60pcs                                  |                            |
| VDR5035F          | VDR5035FW          | VDR5035FE         | VDR5035FB          | 15×40                      | 8                        | 12                         | 16~22pcs                                  |                            |
| VDR1540F          | VDR1540FW          | VDR1540FE         | VDR1540FB          | 20×40                      | 8                        | 12                         | 16~22pcs                                  |                            |
| VDR2040F          | VDR2040FW          | VDR2040FE         | VDR2040FB          | 25×40                      | 8                        | 12                         | 20~35pcs                                  |                            |
| VDR2540F          | VDR2540FW          | VDR2540FE         | VDR2540FB          | 35×40                      | 8                        | 12                         | 30~45pcs                                  |                            |
| VDR3540F          | VDR3540FW          | VDR3540FE         | VDR3540FB          | 40×40                      | 8                        | 12                         | 60~70pcs                                  |                            |
| VDR4040F          | VDR4040FW          | VDR4040FE         | VDR4040FB          | 60×40                      | 8                        | 12                         | 100~115pcs                                |                            |
| VDR6040F          | VDR6040FW          | VDR6040FE         | VDR6040FB          | 80×40                      | 8                        | 12                         | 120~135pcs                                |                            |
| VDR8040F          | VDR8040FW          | VDR8040FE         | VDR8040FB          | 100×40                     | 8                        | 12                         | 120~135pcs                                |                            |
| VDR10040F         | VDR10040FW         | VDR10040FE        | VDR10040FB         | 120×40                     | 8                        | 12                         | 140~155pcs                                |                            |
| VDR12040F         | VDR12040FW         | VDR12040FE        | VDR12040FB         |                            |                          |                            |   | Including truning and lids |

# RCCN 日成VDRF型环保阻燃线槽 Wide Slot Wiring Duct

| 型号 Item No.       |                    |                   |                    | 宽×高<br>High X width<br>W×H | 孔宽<br>Slot width<br>Q | 齿宽<br>Finger width<br>P | 电线容量<br>以2.0平方计算<br>Wire capability/2.0sq | 标准长度<br>Standard Length |
|-------------------|--------------------|-------------------|--------------------|----------------------------|-----------------------|-------------------------|---|-------------------------|
| 灰色Gray<br>RAL7030 | 白色White<br>RAL9016 | 蓝色Blue<br>RAL5015 | 黑色Black<br>RAL9005 |                            |                       |                         |   |                         |
| VDR2545F          | VDR2545FW          | VDR2545FE         | VDR2545FB          | 25×45                      | 8                     | 12                      | 20~25pcs                                  | 每支<br>2米<br>含槽底槽盖       |
| VDR3345F          | VDR3345FW          | VDR3345FE         | VDR3345FB          | 33×45                      | 8                     | 12                      | 40~55pcs                                  |                         |
| VDR4545F          | VDR4545FW          | VDR4545FE         | VDR4545FB          | 45×45                      | 8                     | 12                      | 60~70pcs                                  |                         |
| VDR6545F          | VDR6545FW          | VDR6545FE         | VDR6545FB          | 65×45                      | 8                     | 12                      | 110~120pcs                                |                         |
| VDR2050F          | VDR2050FW          | VDR2050FE         | VDR2050FB          | 20×50                      | 8                     | 12                      | 18~28pcs                                  |                         |
| VDR2550F          | VDR2550FW          | VDR2550FE         | VDR2550FB          | 25×50                      | 8                     | 12                      | 20~30pcs                                  |                         |
| VDR3050F          | VDR3050FW          | VDR3050FE         | VDR3050FB          | 30×50                      | 8                     | 12                      | 25~40pcs                                  |                         |
| VDR3550F          | VDR3550FW          | VDR3550FE         | VDR3550FB          | 35×50                      | 8                     | 12                      | 40~60pcs                                  |                         |
| VDR4050F          | VDR4050FW          | VDR4050FE         | VDR4050FB          | 40×50                      | 8                     | 12                      | 60~70pcs                                  |                         |
| VDR4550F          | VDR4550FW          | VDR4550FE         | VDR4550FB          | 45×50                      | 8                     | 12                      | 70~80pcs                                  |                         |
| VDR5050F          | VDR5050FW          | VDR5050FE         | VDR5050FB          | 50×50                      | 8                     | 12                      | 80~90pcs                                  |                         |
| VDR5550F          | VDR5550FW          | VDR5550FE         | VDR5550FB          | 55×50                      | 8                     | 12                      | 85~95pcs                                  |                         |
| VDR6050F          | VDR6050FW          | VDR6050FE         | VDR6050FB          | 60×50                      | 8                     | 12                      | 100~120pcs                                |                         |
| VDR7550F          | VDR7550FW          | VDR7550FE         | VDR7550FB          | 75×50                      | 8                     | 12                      | 150~170pcs                                |                         |
| VDR8050F          | VDR8050FW          | VDR8050FE         | VDR8050FB          | 80×50                      | 8                     | 12                      | 160~180pcs                                |                         |
| VDR10050F         | VDR10050FW         | VDR10050FE        | VDR10050FB         | 100×50                     | 8                     | 12                      | 200~250pcs                                |                         |
| VDR12555F         | VDR12555FW         | VDR12555FE        | VDR12555FB         | 125×55                     | 8                     | 8                       | 220~270pcs                                |                         |
| VDR2060F          | VDR2060FW          | VDR2060FE         | VDR2060FB          | 20×60                      | 8                     | 12                      | 35~45pcs                                  |                         |
| VDR2560F          | VDR2560FW          | VDR2560FE         | VDR2560FB          | 25×60                      | 8                     | 12                      | 40~50pcs                                  |                         |
| VDR3060F          | VDR3060FW          | VDR3060FE         | VDR3060FB          | 30×60                      | 8                     | 12                      | 60~80pcs                                  |                         |
| VDR3560F          | VDR3560FW          | VDR3560FE         | VDR3560FB          | 35×60                      | 8                     | 12                      | 90~105pcs                                 |                         |
| VDR4060F          | VDR4060FW          | VDR4060FE         | VDR4060FB          | 40×60                      | 8                     | 12                      | 100~115pcs                                |                         |
| VDR4560F          | VDR4560FW          | VDR4560FE         | VDR4560FB          | 45×60                      | 8                     | 12                      | 110~125pcs                                |                         |
| VDR5060F          | VDR5060FW          | VDR5060FE         | VDR5060FB          | 50×60                      | 8                     | 12                      | 120~135pcs                                |                         |
| VDR6060F          | VDR6060FW          | VDR6060FE         | VDR6060FB          | 60×60                      | 8                     | 12                      | 120~135pcs                                |                         |
| VDR8060F          | VDR8060FW          | VDR8060FE         | VDR8060FB          | 80×60                      | 8                     | 12                      | 180~210pcs                                |                         |
| VDR10060F         | VDR10060FW         | VDR10060FE        | VDR10060FB         | 100×60                     | 8                     | 12                      | 240~290pcs                                |                         |
| VDR11060F         | VDR11060FW         | VDR11060FE        | VDR11060FB         | 110×60                     | 8                     | 12                      | 250~300pcs                                |                         |
| VDR12060F         | VDR12060FW         | VDR12060FE        | VDR12060FB         | 120×60                     | 8                     | 12                      | 260~320pcs                                |                         |
| VDR15060F         | VDR15060FW         | VDR15060FE        | VDR15060FB         | 150×60                     | 8                     | 12                      | 300~360pcs                                |                         |
| VDR2565F          | VDR2565FW          | VDR2565FE         | VDR2565FB          | 25×65                      | 8                     | 12                      | 40~50pcs                                  |                         |
| VDR3365F          | VDR3365FW          | VDR3365FE         | VDR3365FB          | 33×65                      | 8                     | 12                      | 40~70pcs                                  |                         |
| VDR4565F          | VDR4565FW          | VDR4565FE         | VDR4565FB          | 45×65                      | 8                     | 12                      | 110~120pcs                                |                         |
| VDR6565F          | VDR6565FW          | VDR6565FE         | VDR6565FB          | 65×65                      | 8                     | 12                      | 180~200pcs                                |                         |
| VDR7265F          | VDR7265FW          | VDR7265FE         | VDR7265FB          | 72×65                      | 8                     | 12                      | 180~230pcs                                |                         |
| VDR2575F          | VDR2575FW          | VDR2575FE         | VDR2575FB          | 25×75                      | 8                     | 12                      | 180~210pcs                                |                         |
| VDR3575F          | VDR3575FW          | VDR3575FE         | VDR3575FB          | 35×75                      | 8                     | 12                      | 180~210pcs                                |                         |
| VDR5075F          | VDR5075FW          | VDR5075FE         | VDR5075FB          | 50×75                      | 8                     | 12                      | 180~210pcs                                |                         |
| VDR7575F          | VDR7575FW          | VDR7575FE         | VDR7575FB          | 75×75                      | 8                     | 12                      | 200~240pcs                                |                         |
| VDR10075F         | VDR10075FW         | VDR10075FE        | VDR10075FB         | 100×75                     | 8                     | 12                      | 250~290pcs                                |                         |
| VDR2580F          | VDR2580FW          | VDR2580FE         | VDR2580FB          | 25×80                      | 8                     | 12                      | 100~120pcs                                |                         |
| VDR3080F          | VDR3080FW          | VDR3080FE         | VDR3080FB          | 30×80                      | 8                     | 12                      | 110~125pcs                                |                         |
| VDR3580F          | VDR3580FW          | VDR3580FE         | VDR3580FB          | 35×80                      | 8                     | 12                      | 110~130pcs                                |                         |
| VDR4080F          | VDR4080FW          | VDR4080FE         | VDR4080FB          | 40×80                      | 8                     | 12                      | 140~160pcs                                |                         |
| VDR4580F          | VDR4580FW          | VDR4580FE         | VDR4580FB          | 45×80                      | 8                     | 12                      | 140~160pcs                                |                         |
| VDR5080F          | VDR5080FW          | VDR5080FE         | VDR5080FB          | 50×80                      | 8                     | 12                      | 160~180pcs                                |                         |
| VDR5580F          | VDR5580FW          | VDR5580FE         | VDR5580FB          | 55×80                      | 8                     | 12                      | 160~180pcs                                |                         |
| VDR6080F          | VDR6080FW          | VDR6080FE         | VDR6080FB          | 60×80                      | 8                     | 12                      | 180~210pcs                                |                         |
| VDR8080F          | VDR8080FW          | VDR8080FE         | VDR8080FB          | 80×80                      | 8                     | 12                      | 240~290pcs                                |                         |
| VDR10080F         | VDR10080FW         | VDR10080FE        | VDR10080FB         | 100×80                     | 8                     | 12                      | 260~350pcs                                |                         |
| VDR12080F         | VDR12080FW         | VDR12080FE        | VDR12080FB         | 120×80                     | 8                     | 12                      | 280~380pcs                                |                         |
| VDR14080F         | VDR14080FW         | VDR14080FE        | VDR14080FB         | 140×80                     | 8                     | 12                      | 350~450pcs                                |                         |
| VDR16080F         | VDR16080FW         | VDR16080FE        | VDR16080FB         | 160×80                     | 8                     | 12                      | 450~550pcs                                |                         |
| VDR25100F         | VDR25100FW         | VDR25100FE        | VDR25100FB         | 25×100                     | 8                     | 12                      | 110~160pcs                                |                         |
| VDR33100F         | VDR33100FW         | VDR33100FE        | VDR33100FB         | 33×100                     | 8                     | 12                      | 130~165pcs                                |                         |
| VDR40100F         | VDR40100FW         | VDR40100FE        | VDR40100FB         | 40×100                     | 8                     | 12                      | 130~175pcs                                |                         |
| VDR50100F         | VDR50100FW         | VDR50100FE        | VDR50100FB         | 50×100                     | 8                     | 12                      | 220~250pcs                                |                         |
| VDR60100F         | VDR60100FW         | VDR60100FE        | VDR60100FB         | 60×100                     | 8                     | 12                      | 240~290pcs                                |                         |
| VDR70100F         | VDR70100FW         | VDR70100FE        | VDR70100FB         | 70×100                     | 8                     | 12                      | 250~340pcs                                |                         |
| VDR75100F         | VDR75100FW         | VDR75100FE        | VDR75100FB         | 75×100                     | 8                     | 12                      | 260~350pcs                                |                         |
| VDR80100F         | VDR80100FW         | VDR80100FE        | VDR80100FB         | 80×100                     | 8                     | 12                      | 260~350pcs                                |                         |
| VDR100100F        | VDR100100FW        | VDR100100FE       | VDR100100FB        | 100×100                    | 8                     | 12                      | 300~400pcs                                |                         |
| VDR120100F        | VDR120100FW        | VDR120100FE       | VDR120100FB        | 120×100                    | 8                     | 12                      | 350~450pcs                                |                         |
| VDR150100F        | VDR150100FW        | VDR150100FE       | VDR150100FB        | 150×100                    | 8                     | 12                      | 400~650pcs                                |                         |
| VDR160100F        | VDR160100FW        | VDR160100FE       | VDR160100FB        | 160×100                    | 8                     | 12                      | 500~750pcs                                |                         |
| VDR100130F        | VDR100130FW        | VDR100130FE       | VDR100130FB        | 100×130                    | 8                     | 12                      | 350~450pcs                                |                         |
| VDR150130F        | VDR150130FW        | VDR150130FE       | VDR150130FB        | 150×130                    | 8                     | 12                      | 400~500pcs                                |                         |
| VDR200100F        | VDR200100FW        | VDR200100FE       | VDR200100FB        | 200×100                    | 8                     | 12                      | 600~800pcs                                |                         |
| VDR200150F        | VDR200150FW        | VDR200150FE       | VDR200150FB        | 200×150                    | 8                     | 12                      | 900~1200pcs                               |                         |
| VDR200200F        | VDR200200FW        | VDR200200FE       | VDR200200FB        | 200×200                    | 8                     | 12                      | 1200~1600pcs                              |                         |

Pcs/Branch  
2M

Including tuning and lids

每支  
2米

含槽底槽盖

Pcs/Branch  
2M

Including tuning and lids

### RCCN 日成HVDRF型环保阻燃线槽 Narrow Slot Wiring Duct



产品材质:采用低卤素硬质PVC料制成,环保无污染,不含铅等有毒物。  
 产品认证:美国UL:E306674 欧洲CE 欧洲环保RoHS,REACH,铁道阻燃低烟。  
 防火等级:UL94V-0,低烟微卤,遇火不燃烧,防火性及绝缘性特佳。  
 产品构造:由槽底及槽盖组成,底槽两侧设有出线孔。  
 颜色:灰色,白色,蓝色,黑色(可定制其它颜色,有起订量要求)  
 工作温度:静态-40°C持续高温至65°C,短时间可达85°C。  
 使用方法:先将底槽固定,将所要配的线装入槽内,盖上槽盖即可。  
 产品特性:1.反扣式槽盖与槽体设计组合后绝不脱落,且接合面平滑,不割伤手及擦损附近配线。  
 2.配线槽65°C内不易断裂,变形,变色,装配省时便利。  
 3.出线孔低、组合容易、拆卸简单、易于配线。

**更多选择:量大可按需求生产所需规格或定制长度,例:HVDR8080F(L=1.7M)**  
 Wide slot/finger design provides greater sidewall rigidity and can be used with a wide range of wire bundle sizes.  
 Certificates:UL:E306674 CE:EN50085 RoHS,REACH。 Made of rigid PVC  
 Work temperature:-40 °c to 65 °c  
 UL94 Flammability Rating of V-0  
 Provided with mounting holes  
 Available color:gray,white,blue,black and other special colors  
**Special length come with MOQ request**



推荐:灰色为常规库存产品,其它颜色有起订量要求。  
 Comment: gray is the common color, other color need more MOQ

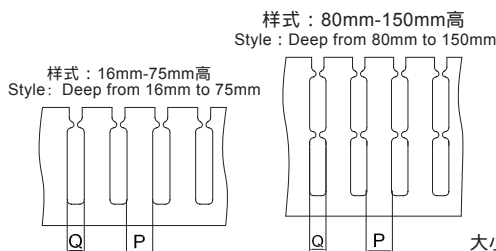
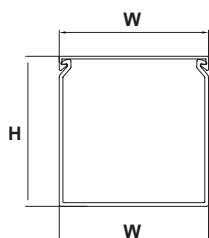

样式: 16mm-72mm宽  
 Style: Width from 16mm to 72mm

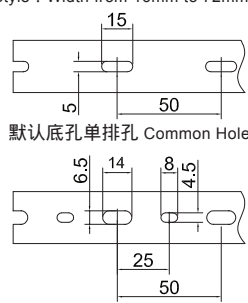

样式: 75mm-140mm宽  
 Style: Width from 75mm to 140mm

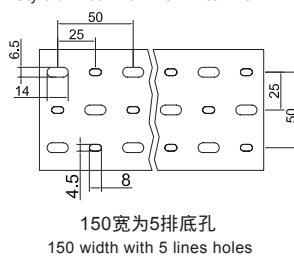

大小孔型号/Eu hole size: HVDR4060F/614

单位/Unit:mm

| 型号 Item No.       |                    |                   |                    | 宽 × 高<br>High X width<br>W×H | 孔宽<br>Slot width<br>Q | 齿宽<br>Finger width<br>P | 电线容量<br>以2.0平方计算<br>Wire capability/2.0sq | 标准长度<br>Standard Length                             |
|-------------------|--------------------|-------------------|--------------------|------------------------------|-----------------------|-------------------------|---|---|
| 灰色Gray<br>RAL7030 | 白色White<br>RAL9016 | 蓝色Blue<br>RAL5015 | 黑色Black<br>RAL9005 | 16×16                        | 5                     | 5                       | 3~10pcs                                   | 每支<br>2米<br><br>含槽底槽盖                               |
| HVDR1616F         | HVDR1616FW         | HVDR1616FE        | HVDR1616FB         | 25×16                        | 5                     | 5                       | 8~12pcs                                   |   |
| HVDR2516F         | HVDR2516FW         | HVDR2516FE        | HVDR2516FB         | 15×20                        | 4                     | 6                       | 8~12pcs                                   |   |
| HVDR1520F         | HVDR1520FW         | HVDR1520FE        | HVDR1520FB         | 20×20                        | 4                     | 6                       | 10~20pcs                                  |   |
| HVDR2020F         | HVDR2020FW         | HVDR2020FE        | HVDR2020FB         | 40×20                        | 4                     | 6                       | 15~30pcs                                  |   |
| HVDR4020F         | HVDR4020FW         | HVDR4020FE        | HVDR4020FB         | 15×25                        | 5                     | 5                       | 5~15pcs                                   |   |
| HVDR1525F         | HVDR1525FW         | HVDR1525FE        | HVDR1525FB         | 20×25                        | 4                     | 6                       | 5~15pcs                                   |   |
| HVDR2025F         | HVDR2025FW         | HVDR2025FE        | HVDR2025FB         | 25×25                        | 4                     | 6                       | 10~25pcs                                  |   |
| HVDR2525F         | HVDR2525FW         | HVDR2525FE        | HVDR2525FB         | 30×25                        | 4                     | 6                       | 12~28pcs                                  |   |
| HVDR3025F         | HVDR3025FW         | HVDR3025FE        | HVDR3025FB         | 40×25                        | 4                     | 6                       | 20~35pcs                                  |   |
| HVDR4025F         | HVDR4025FW         | HVDR4025FE        | HVDR4025FB         | 50×25                        | 4                     | 6                       | 12~28pcs                                  |   |
| HVDR5025F         | HVDR5025FW         | HVDR5025FE        | HVDR5025FB         | 15×30                        | 4                     | 6                       | 8~15pcs                                   |   |
| HVDR1530F         | HVDR1530FW         | HVDR1530FE        | HVDR1530FB         | 20×30                        | 4                     | 6                       | 25~35pcs                                  |   |
| HVDR2030F         | HVDR2030FW         | HVDR2030FE        | HVDR2030FB         | 25×30                        | 4                     | 6                       | 25~35pcs                                  |   |
| HVDR2530F         | HVDR2530FW         | HVDR2530FE        | HVDR2530FB         | 30×30                        | 4                     | 6                       | 25~35pcs                                  |   |
| HVDR3030F         | HVDR3030FW         | HVDR3030FE        | HVDR3030FB         | 40×30                        | 4                     | 6                       | 30~40pcs                                  |   |
| HVDR4030F         | HVDR4030FW         | HVDR4030FE        | HVDR4030FB         | 50×30                        | 4                     | 6                       | 40~50pcs                                  |   |
| HVDR5030F         | HVDR5030FW         | HVDR5030FE        | HVDR5030FB         | 60×30                        | 4                     | 6                       | 50~60pcs                                  |   |
| HVDR6030F         | HVDR6030FW         | HVDR6030FE        | HVDR6030FB         | 22×33                        | 4                     | 6                       | 25~35pcs                                  |   |
| HVDR2233F         | HVDR2233FW         | HVDR2233FE        | HVDR2233FB         | 33×33                        | 4                     | 6                       | 35~45pcs                                  |   |
| HVDR3333F         | HVDR3333FW         | HVDR3333FE        | HVDR3333FB         | 20×35                        | 4                     | 6                       | 30~40pcs                                  |   |
| HVDR2035F         | HVDR2035FW         | HVDR2035FE        | HVDR2035FB         | 35×35                        | 4                     | 6                       | 35~45pcs                                  |   |
| HVDR3535F         | HVDR3535FW         | HVDR3535FE        | HVDR3535FB         | 50×35                        | 4                     | 6                       | 40~60pcs                                  |   |
| HVDR5035F         | HVDR5035FW         | HVDR5035FE        | HVDR5035FB         | 15×40                        | 4                     | 6                       | 16~22pcs                                  |   |
| HVDR1540F         | HVDR1540FW         | HVDR1540FE        | HVDR1540FB         | 20×40                        | 4                     | 6                       | 16~22pcs                                  |   |
| HVDR2040F         | HVDR2040FW         | HVDR2040FE        | HVDR2040FB         | 25×40                        | 4                     | 6                       | 20~35pcs                                  |   |
| HVDR2540F         | HVDR2540FW         | HVDR2540FE        | HVDR2540FB         | 35×40                        | 4                     | 6                       | 30~45pcs                                  |   |
| HVDR3540F         | HVDR3540FW         | HVDR3540FE        | HVDR3540FB         | 40×40                        | 4                     | 6                       | 60~70pcs                                  |   |
| HVDR4040F         | HVDR4040FW         | HVDR4040FE        | HVDR4040FB         | 60×40                        | 4                     | 6                       | 100~115pcs                                |   |
| HVDR6040F         | HVDR6040FW         | HVDR6040FE        | HVDR6040FB         | 80×40                        | 4                     | 6                       | 120~135pcs                                |   |
| HVDR8040F         | HVDR8040FW         | HVDR8040FE        | HVDR8040FB         | 100×40                       | 4                     | 6                       | 120~135pcs                                |   |
| HVDR10040F        | HVDR10040FW        | HVDR10040FE       | HVDR10040FB        | 120×40                       | 4                     | 6                       | 140~155pcs                                |   |
| HVDR12040F        | HVDR12040FW        | HVDR12040FE       | HVDR12040FB        |                              |                       |                         |   | Pcs/Branch<br>2M<br><br>Including trunking and lids |

# RCCN 日成HVDRF型环保阻燃线槽 Narrow Slot Wiring Duct

| 型号 Item No.       |                    |                   |                    | 宽×高<br>High X width<br>W×H | 孔宽<br>Slot width<br>Q | 齿宽<br>Finger width<br>P | 电线容量<br>以2.0平方计算<br>Wire capability/2.0sq | 标准长度<br>Standard Length |
|-------------------|--------------------|-------------------|--------------------|----------------------------|-----------------------|-------------------------|---|-------------------------|
| 灰色Gray<br>RAL7030 | 白色White<br>RAL9016 | 蓝色Blue<br>RAL5015 | 黑色Black<br>RAL9005 |                            |                       |                         |   |                         |
| HVDR2545F         | HVDR2545FW         | HVDR2545FE        | HVDR2545FB         | 25×45                      | 4                     | 6                       | 20~25pcs                                  | 每支<br>2米<br>含槽底槽盖       |
| HVDR3345F         | HVDR3345FW         | HVDR3345FE        | HVDR3345FB         | 33×45                      | 4                     | 6                       | 40~55pcs                                  |                         |
| HVDR4545F         | HVDR4545FW         | HVDR4545FE        | HVDR4545FB         | 45×45                      | 4                     | 6                       | 60~70pcs                                  |                         |
| HVDR6545F         | HVDR6545FW         | HVDR6545FE        | HVDR6545FB         | 65×45                      | 4                     | 6                       | 110~120pcs                                |                         |
| HVDR2050F         | HVDR2050FW         | HVDR2050FE        | HVDR2050FB         | 20×50                      | 4                     | 6                       | 18~28pcs                                  |                         |
| HVDR2550F         | HVDR2550FW         | HVDR2550FE        | HVDR2550FB         | 25×50                      | 4                     | 6                       | 20~30pcs                                  |                         |
| HVDR3050F         | HVDR3050FW         | HVDR3050FE        | HVDR3050FB         | 30×50                      | 4                     | 6                       | 25~40pcs                                  |                         |
| HVDR3550F         | HVDR3550FW         | HVDR3550FE        | HVDR3550FB         | 35×50                      | 4                     | 6                       | 40~60pcs                                  |                         |
| HVDR4050F         | HVDR4050FW         | HVDR4050FE        | HVDR4050FB         | 40×50                      | 4                     | 6                       | 60~70pcs                                  |                         |
| HVDR4550F         | HVDR4550FW         | HVDR4550FE        | HVDR4550FB         | 45×50                      | 4                     | 6                       | 70~80pcs                                  |                         |
| HVDR5050F         | HVDR5050FW         | HVDR5050FE        | HVDR5050FB         | 50×50                      | 4                     | 6                       | 80~90pcs                                  |                         |
| HVDR5550F         | HVDR5550FW         | HVDR5550FE        | HVDR5550FB         | 55×50                      | 4                     | 6                       | 85~95pcs                                  |                         |
| HVDR6050F         | HVDR6050FW         | HVDR6050FE        | HVDR6050FB         | 60×50                      | 4                     | 6                       | 100~120pcs                                |                         |
| HVDR7550F         | HVDR7550FW         | HVDR7550FE        | HVDR7550FB         | 75×50                      | 4                     | 6                       | 150~170pcs                                |                         |
| HVDR8050F         | HVDR8050FW         | HVDR8050FE        | HVDR8050FB         | 80×50                      | 4                     | 6                       | 160~180pcs                                |                         |
| HVDR10050F        | HVDR10050FW        | HVDR10050FE       | HVDR10050FB        | 100×50                     | 4                     | 6                       | 200~250pcs                                |                         |
| HVDR12555F        | HVDR12555FW        | HVDR12555FE       | HVDR12555FB        | 125×55                     | 4                     | 6                       | 220~270pcs                                |                         |
| HVDR2060F         | HVDR2060FW         | HVDR2060FE        | HVDR2060FB         | 20×60                      | 4                     | 6                       | 35~45pcs                                  |                         |
| HVDR2560F         | HVDR2560FW         | HVDR2560FE        | HVDR2560FB         | 25×60                      | 4                     | 6                       | 40~50pcs                                  |                         |
| HVDR3060F         | HVDR3060FW         | HVDR3060FE        | HVDR3060FB         | 30×60                      | 4                     | 6                       | 60~80pcs                                  |                         |
| HVDR3560F         | HVDR3560FW         | HVDR3560FE        | HVDR3560FB         | 35×60                      | 4                     | 6                       | 90~105pcs                                 |                         |
| HVDR4060F         | HVDR4060FW         | HVDR4060FE        | HVDR4060FB         | 40×60                      | 4                     | 6                       | 100~115pcs                                |                         |
| HVDR4560F         | HVDR4560FW         | HVDR4560FE        | HVDR4560FB         | 45×60                      | 4                     | 6                       | 110~125pcs                                |                         |
| HVDR5060F         | HVDR5060FW         | HVDR5060FE        | HVDR5060FB         | 50×60                      | 4                     | 6                       | 120~135pcs                                |                         |
| HVDR6060F         | HVDR6060FW         | HVDR6060FE        | HVDR6060FB         | 60×60                      | 4                     | 6                       | 120~135pcs                                |                         |
| HVDR8060F         | HVDR8060FW         | HVDR8060FE        | HVDR8060FB         | 80×60                      | 4                     | 6                       | 180~210pcs                                |                         |
| HVDR10060F        | HVDR10060FW        | HVDR10060FE       | HVDR10060FB        | 100×60                     | 4                     | 6                       | 240~290pcs                                |                         |
| HVDR11060F        | HVDR11060FW        | HVDR11060FE       | HVDR11060FB        | 110×60                     | 4                     | 6                       | 250~300pcs                                |                         |
| HVDR12060F        | HVDR12060FW        | HVDR12060FE       | HVDR12060FB        | 120×60                     | 4                     | 6                       | 260~320pcs                                |                         |
| HVDR15060F        | HVDR15060FW        | HVDR15060FE       | HVDR15060FB        | 150×60                     | 4                     | 6                       | 300~360pcs                                |                         |
| HVDR2565F         | HVDR2565FW         | HVDR2565FE        | HVDR2565FB         | 25×65                      | 4                     | 6                       | 40~50pcs                                  |                         |
| HVDR3365F         | HVDR3365FW         | HVDR3365FE        | HVDR3365FB         | 33×65                      | 4                     | 6                       | 40~70pcs                                  |                         |
| HVDR4565F         | HVDR4565FW         | HVDR4565FE        | HVDR4565FB         | 45×65                      | 4                     | 6                       | 110~120pcs                                |                         |
| HVDR6565F         | HVDR6565FW         | HVDR6565FE        | HVDR6565FB         | 65×65                      | 4                     | 6                       | 180~200pcs                                |                         |
| HVDR7265F         | HVDR7265FW         | HVDR7265FE        | HVDR7265FB         | 72×65                      | 4                     | 6                       | 180~230pcs                                |                         |
| HVDR2575F         | HVDR2575FW         | HVDR2575FE        | HVDR2575FB         | 25×75                      | 4                     | 6                       | 180~210pcs                                |                         |
| HVDR3575F         | HVDR3575FW         | HVDR3575FE        | HVDR3575FB         | 35×75                      | 4                     | 6                       | 180~210pcs                                |                         |
| HVDR5075F         | HVDR5075FW         | HVDR5075FE        | HVDR5075FB         | 50×75                      | 4                     | 6                       | 180~210pcs                                |                         |
| HVDR7575F         | HVDR7575FW         | HVDR7575FE        | HVDR7575FB         | 75×75                      | 4                     | 6                       | 200~240pcs                                |                         |
| HVDR10075F        | HVDR10075FW        | HVDR10075FE       | HVDR10075FB        | 100×75                     | 4                     | 6                       | 250~290pcs                                |                         |
| HVDR2580F         | HVDR2580FW         | HVDR2580FE        | HVDR2580FB         | 25×80                      | 4                     | 6                       | 100~120pcs                                |                         |
| HVDR3080F         | HVDR3080FW         | HVDR3080FE        | HVDR3080FB         | 30×80                      | 4                     | 6                       | 110~125pcs                                |                         |
| HVDR3580F         | HVDR3580FW         | HVDR3580FE        | HVDR3580FB         | 35×80                      | 4                     | 6                       | 110~130pcs                                |                         |
| HVDR4080F         | HVDR4080FW         | HVDR4080FE        | HVDR4080FB         | 40×80                      | 4                     | 6                       | 140~160pcs                                |                         |
| HVDR4580F         | HVDR4580FW         | HVDR4580FE        | HVDR4580FB         | 45×80                      | 4                     | 6                       | 140~160pcs                                |                         |
| HVDR5080F         | HVDR5080FW         | HVDR5080FE        | HVDR5080FB         | 50×80                      | 4                     | 6                       | 160~180pcs                                |                         |
| HVDR5580F         | HVDR5580FW         | HVDR5580FE        | HVDR5580FB         | 55×80                      | 4                     | 6                       | 160~180pcs                                |                         |
| HVDR6080F         | HVDR6080FW         | HVDR6080FE        | HVDR6080FB         | 60×80                      | 4                     | 6                       | 180~210pcs                                |                         |
| HVDR8080F         | HVDR8080FW         | HVDR8080FE        | HVDR8080FB         | 80×80                      | 4                     | 6                       | 240~290pcs                                |                         |
| HVDR10080F        | HVDR10080FW        | HVDR10080FE       | HVDR10080FB        | 100×80                     | 4                     | 6                       | 260~350pcs                                |                         |
| HVDR12080F        | HVDR12080FW        | HVDR12080FE       | HVDR12080FB        | 120×80                     | 4                     | 6                       | 280~380pcs                                |                         |
| HVDR14080F        | HVDR14080FW        | HVDR14080FE       | HVDR14080FB        | 140×80                     | 4                     | 6                       | 350~450pcs                                |                         |
| HVDR16080F        | HVDR16080FW        | HVDR16080FE       | HVDR16080FB        | 160×80                     | 4                     | 6                       | 450~550pcs                                |                         |
| HVDR25100F        | HVDR25100FW        | HVDR25100FE       | HVDR25100FB        | 25×100                     | 4                     | 6                       | 110~160pcs                                |                         |
| HVDR33100F        | HVDR33100FW        | HVDR33100FE       | HVDR33100FB        | 33×100                     | 4                     | 6                       | 130~165pcs                                |                         |
| HVDR40100F        | HVDR40100FW        | HVDR40100FE       | HVDR40100FB        | 40×100                     | 4                     | 6                       | 130~175pcs                                |                         |
| HVDR50100F        | HVDR50100FW        | HVDR50100FE       | HVDR50100FB        | 50×100                     | 4                     | 6                       | 220~250pcs                                |                         |
| HVDR60100F        | HVDR60100FW        | HVDR60100FE       | HVDR60100FB        | 60×100                     | 4                     | 6                       | 240~290pcs                                |                         |
| HVDR70100F        | HVDR70100FW        | HVDR70100FE       | HVDR70100FB        | 70×100                     | 4                     | 6                       | 250~340pcs                                |                         |
| HVDR75100F        | HVDR75100FW        | HVDR75100FE       | HVDR75100FB        | 75×100                     | 4                     | 6                       | 260~350pcs                                |                         |
| HVDR80100F        | HVDR80100FW        | HVDR80100FE       | HVDR80100FB        | 80×100                     | 4                     | 6                       | 260~350pcs                                |                         |
| HVDR100100F       | HVDR100100FW       | HVDR100100FE      | HVDR100100FB       | 100×100                    | 4                     | 6                       | 300~400pcs                                |                         |
| HVDR120100F       | HVDR120100FW       | HVDR120100FE      | HVDR120100FB       | 120×100                    | 4                     | 6                       | 350~450pcs                                |                         |
| HVDR150100F       | HVDR150100FW       | HVDR150100FE      | HVDR150100FB       | 150×100                    | 4                     | 6                       | 400~650pcs                                |                         |
| HVDR160100F       | HVDR160100FW       | HVDR160100FE      | HVDR160100FB       | 160×100                    | 4                     | 6                       | 500~750pcs                                |                         |
| HVDR100130F       | HVDR100130FW       | HVDR100130FE      | HVDR100130FB       | 100×130                    | 4                     | 6                       | 350~450pcs                                |                         |
| HVDR150130F       | HVDR150130FW       | HVDR150130FE      | HVDR150130FB       | 150×130                    | 4                     | 6                       | 400~500pcs                                |                         |
| HVDR200100F       | HVDR200100FW       | HVDR200100FE      | HVDR200100FB       | 200×100                    | 4                     | 6                       | 600~800pcs                                |                         |
| HVDR200150F       | HVDR200150FW       | HVDR200150FE      | HVDR200150FB       | 200×150                    | 4                     | 6                       | 900~1200pcs                               |                         |
| HVDR200200F       | HVDR200200FW       | HVDR200200FE      | HVDR200200FB       | 200×200                    | 4                     | 6                       | 1200~1600pcs                              |                         |

 每支  
2米  
含槽底槽盖  
Pcs/Branch  
2M  
Including tuning and lids

 每支  
2米  
含槽底槽盖  
Pcs/Branch  
2M  
Including tuning and lids

## RCCN 日成TS型电器安装钢导轨 Din Rails

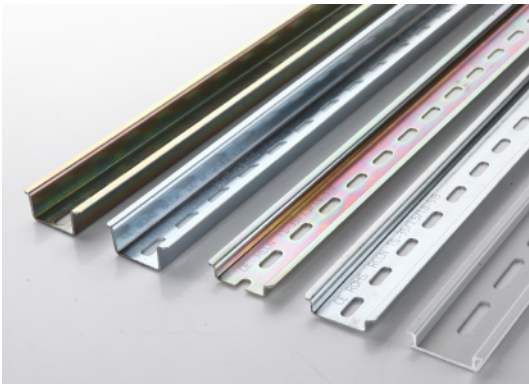

产品材质: 优质高强度冷轧钢电镀。产品标准: 欧洲EN50022  
颜色种类: 镀镍黄色, 镀白锌。工作温度: -40°C持续高温至100°C  
使用方法: 固定于面板后即可安装电器。

产品特性: 具美观及抗重压之功能, 尺寸十分精确, 耐腐蚀。

定制长度或孔位有起订量要求, 环保型ROHS为选购品。

双腔导轨工具型号: TS-2X, 适用于TS357.5/TS3515切割

四腔导轨工具型号: TS-4X, 适用于TS357.5/TS3515/LS357.51.1/LS35151.5

Material: high quality and strength cold rolled steel with electroplate

EN50022 Product standard: EN50022

Color: yellow plated nickle, silver plated zinc

Din rail cutter: TS-2X suitable for cutting 35 7.5/35 15

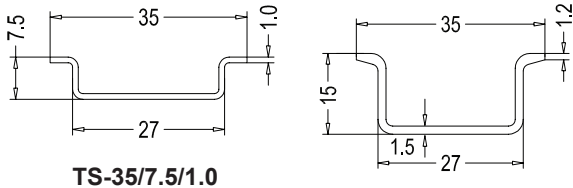

TS-35/7.5/1.0

TS-35/15/1.5

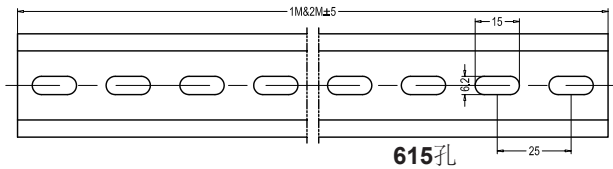

615孔

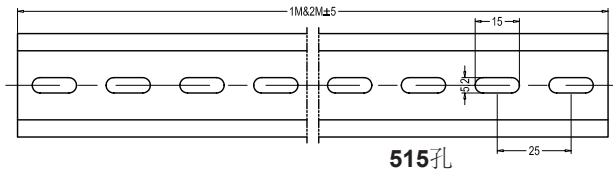

515孔

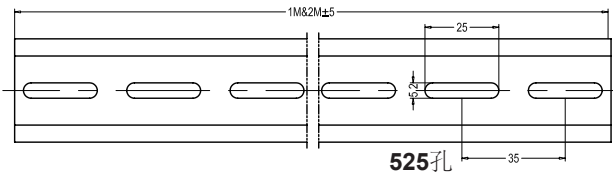

525孔

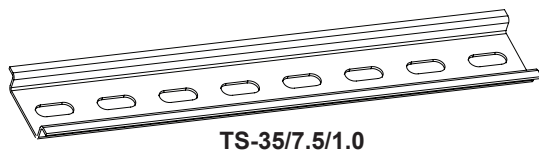

TS-35/7.5/1.0

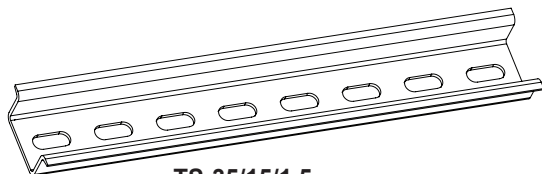

TS-35/15/1.5

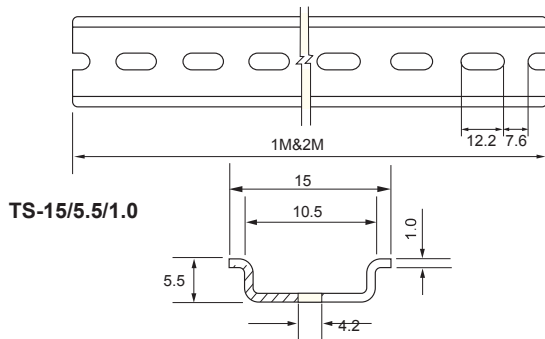

TS-15/5.5/1.0

| 型号 Item No.               | 材质 Material                      | 配套工具 Supporting tools | 包装/箱 Packing/ carton |
|---------------------------|----------------------------------|-----------------------|----------------------|
| <b>TS-35/7.5系列 Catena</b> |                                  |                       |                      |
| TS-35/7.5/1.0/1M-615      | 彩锌/Colorful zinc                 | TS-1                  | 50M                  |
| TS-35/7.5/1.0/1M-515      | 彩锌/Colorful zinc                 |                       | 50M                  |
| TS-35/7.5/1.0/1M-525      | 彩锌/Colorful zinc                 |                       | 50M                  |
| TS-35/7.5/1.0/1M/W-615    | 环保白锌/ROHS approve                |                       | 50M                  |
| TS-35/7.5/1.0/1M/W-515    | 环保白锌/ROHS approve                |                       | 50M                  |
| TS-35/7.5/1.0/1M/W-525    | 环保白锌/ROHS approve                |                       | 50M                  |
| TS-35/7.5/1.0/2M-615      | 彩锌/Colorful zinc                 |                       | 100M                 |
| TS-35/7.5/1.0/2M-515      | 彩锌/Colorful zinc                 |                       | 100M                 |
| TS-35/7.5/1.0/2M-525      | 彩锌/Colorful zinc                 |                       | 100M                 |
| TS-35/7.5/1.0/2M/W-615    | 环保白锌/ROHS approve                |                       | 100M                 |
| TS-35/7.5/1.0/2M/W-515    | 环保白锌/ROHS approve                |                       | 100M                 |
| TS-35/7.5/1.0/2M/W-525    | 环保白锌/ROHS approve                |                       | 100M                 |
| TS-35/7.5/1.0/1M-N        | 彩锌无底孔/Colorful zinc without hole | 50M                   |                      |
| TS-35/7.5/1.0/1M/W-N      | 白锌无底孔/White zinc without hole    | 50M                   |                      |
| TS-35/7.5/1.0/2M--N       | 彩锌无底孔/Colorful zinc without hole | 100M                  |                      |
| TS-35/7.5/1.0/2M/W-N      | 白锌无底孔/White zinc without hole    | 100M                  |                      |

**TS-35/15系列 Catena**

|                       |                                  |      |     |
|-----------------------|----------------------------------|------|-----|
| TS-35/15/1.5/1M-615   | 彩锌/Colorful zinc                 | TS-2 | 30M |
| TS-35/15/1.5/1M/W-615 | 环保白锌/ROHS approve                |      | 30M |
| TS-35/15/1.5/2M-615   | 彩锌/Colorful zinc                 |      | 60M |
| TS-35/15/1.5/2M/W-615 | 环保白锌/ROHS approve                |      | 60M |
| TS-35/15/1.5/1M-N     | 彩锌无底孔/Colorful zinc without hole |      | 30M |
| TS-35/15/1.5/1M/W-N   | 白锌无底孔/White zinc without hole    |      | 30M |
| TS-35/15/1.5/2M-N     | 彩锌无底孔/Colorful zinc without hole |      | 60M |
| TS-35/15/1.5/2M/W-N   | 白锌无底孔/White zinc without hole    |      | 60M |

**TS-15/5.5系列 Catena**

|                        |                   |       |      |
|------------------------|-------------------|-------|------|
| TS-15/5.5/1.0/1M-412   | 彩锌/Colorful zinc  | TS-1S | 100M |
| TS-15/5.5/1.0/2M-412   | 彩锌/Colorful zinc  |       | 200M |
| TS-15/5.5/1.0/1M/W-412 | 环保白锌/ROHS approve |       | 100M |
| TS-15/5.5/1.0/2M/W-412 | 环保白锌/ROHS approve |       | 200M |

